

**-60V, -3.0A P-Channel Power MOSFET**

**GENERAL DESCRIPTION**

The Power MOSFET has extremely low on resistance, making it especially suitable for applications which require superior power density and outstanding efficiency.

**Features**

- ◆  $V_{DS} = -60V$ ,  $I_D = -3.0A$
- ◆  $R_{DS(ON)}$   
TYP:  $150m\Omega @ V_{GS} = -10V$

**Applications**

- ◆ Power factor correction (PFC)
- ◆ Switched mode power supplies (SMPS)
- ◆ Uninterruptible power supply (UPS)
- ◆ LED lighting power

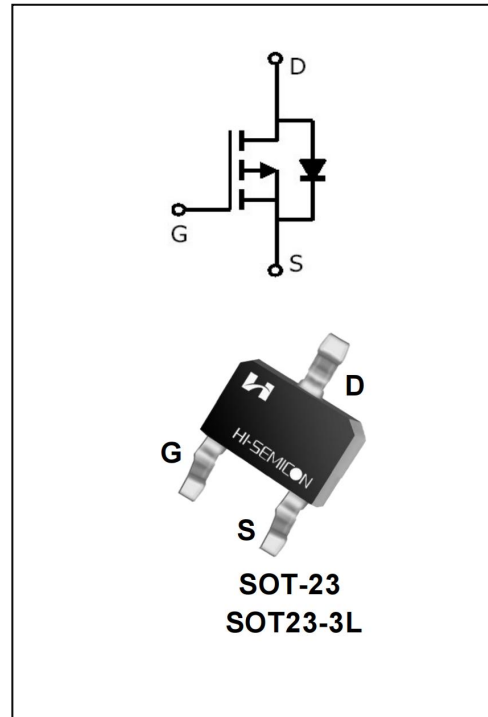

**ORDERING INFORMATION**

Part No.	Package	Marking	Material	Packing
SFS6003PT	SOT-23 SOT-23-3L	6003PT	Pb Free	Reel

## ABSOLUTE MAXIMUM RATINGS (T<sub>J</sub>=25°C unless otherwise noted)

Characteristics		Symbol	Ratings	Unit
Drain-Source Voltage		V <sub>DS</sub>	-60	V
Gate-Source Voltage		V <sub>GS</sub>	±20	
Drain Current	T <sub>C</sub> = 25°C	I <sub>D</sub>	-3.0	A
	T <sub>C</sub> = 75°C		-1.7	
Drain Current Pulsed(Note 1)		I <sub>DM</sub>	-10	
Power Dissipation(T <sub>C</sub> =25°C) -Derate above 25°C		P <sub>D</sub>	1.8	W
Operation Junction Temperature Range		T <sub>J</sub>	-55~+150	°C
Storage Temperature Range		T <sub>stg</sub>	-55~+150	
Maximum lead temperature for soldering purposes, 1/8" from case for 5 seconds		TL	300	

## ELECTRICAL CHARACTERISTICS

Characteristics	Symbol	Test conditions	Min.	Typ.	Max.	Unit
Off Characteristics						
Drain -Source Breakdown Voltage	B <sub>VDSS</sub>	V <sub>GS</sub> = 0V, I <sub>D</sub> = -250μA	-60	--	--	V
Drain-Source Leakage Current	I <sub>DSS</sub>	V <sub>DS</sub> = -60V, V <sub>GS</sub> = 0V	--	--	1	uA
Gate-Source Leakage Current	I <sub>GSS</sub>	V <sub>GS</sub> = 20V, V <sub>DS</sub> = 0V	--	--	100	nA
Gate-Source Leakage Current	I <sub>GSS</sub>	V <sub>GS</sub> = -20V, V <sub>DS</sub> = 0V	--	--	-100	
On Characteristics						
Gate Threshold Voltage	V <sub>GS(th)</sub>	V <sub>GS</sub> = V <sub>DS</sub> , I <sub>D</sub> = -250μA	-1.2	-1.8	-2.4	V
Static Drain- Source On State Resistance	R <sub>DS(on)</sub>	V <sub>GS</sub> = -10V, I <sub>D</sub> = -2.0A	--	150	180	mΩ
		V <sub>GS</sub> = -4.5V, I <sub>D</sub> = -2.0A	--	191	210	
Dynamic Characteristics						
Input Capacitance	C <sub>iss</sub>	V <sub>DS</sub> = -25V V <sub>GS</sub> = 0V f=1.0MHZ	--	787	--	pF
Output Capacitance	C <sub>oss</sub>		--	42	--	
Reverse Transfer Capacitance	C <sub>rss</sub>		--	31	--	
Switching Characteristics						
Turn-on Delay Time	t <sub>d(on)</sub>	V <sub>DD</sub> = -30V, V <sub>GS</sub> = -10V R <sub>G</sub> = 3Ω, I <sub>D</sub> =-2A (Note 2.3)	--	43	--	nS
Turn-on Rise Time	t <sub>r</sub>		--	32	--	
Turn-off Delay Time	t <sub>d(off)</sub>		--	14	--	
Turn-off Fall Time	t <sub>f</sub>		--	9	--	
Total Gate Charge	Q <sub>g</sub>	V <sub>DS</sub> =-30V, I <sub>D</sub> =-2A V <sub>GS</sub> =-10V	--	9.6	--	nC
Gate-Source Charge	Q <sub>gs</sub>		--	1.8	--	
Gate-Drain Charge	Q <sub>gd</sub>		--	5.0	--	

SOURCE-DRAIN DIODE RATINGS AND CHARACTERISTICS

Characteristics	Symbol	Test conditions	Min.	Typ.	Max.	Unit
Continuous Source Current	$I_S$	Integral Reverse P-N Junction Diode in the MOSFET	--	--	-2.5	A
Pulsed Source Current	$I_{SM}$		--	--	-10	
Diode Forward Voltage	$V_{SD}$	$I_S = -2A, V_{GS} = 0V$	--	-0.87	-1.2	V

NOTE:

1. Pulse width limited by maximum junction temperature
2. Pulse Test: Pulse width  $\leq 300\mu s$ , Duty cycle  $\leq 2\%$
3. Essentially independent of operating temperature

Typical Performance Characteristics

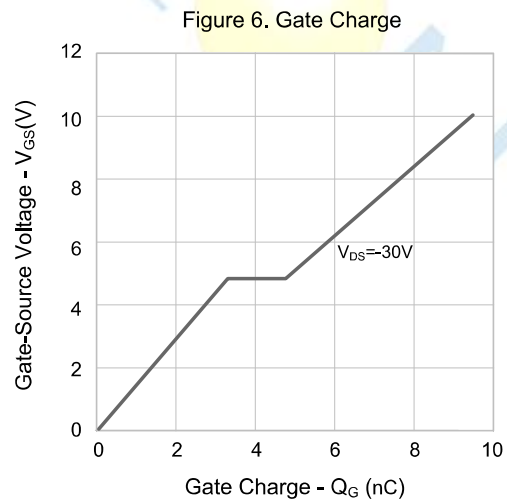
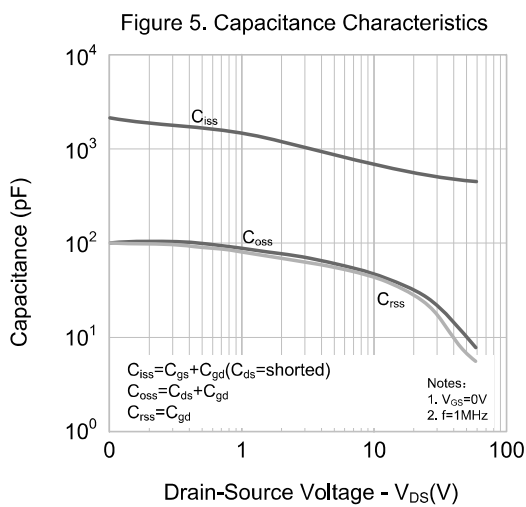
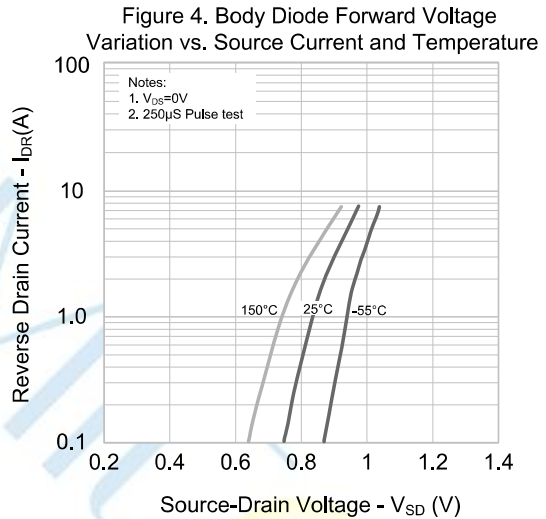
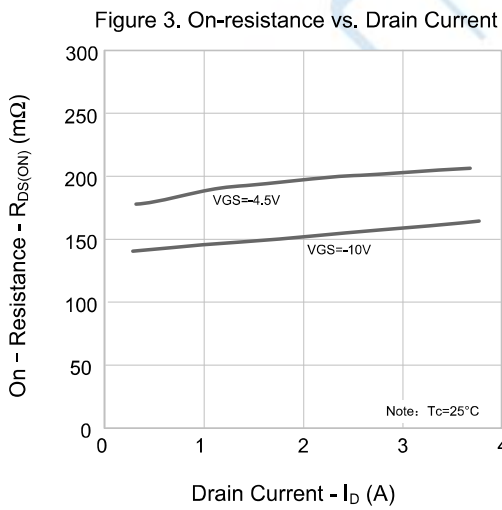
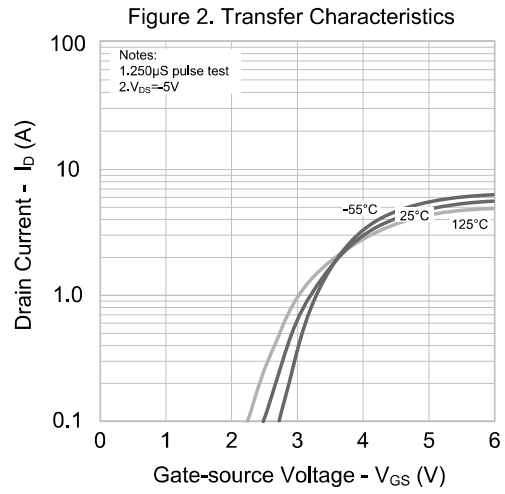
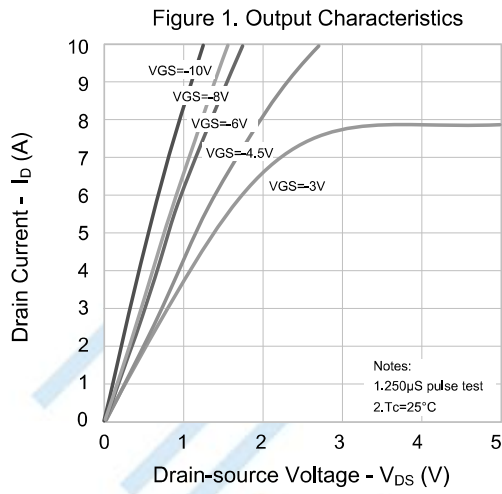

Typical Performance Characteristics

Figure 7. Breakdown Voltage vs. Temperature Characteristics

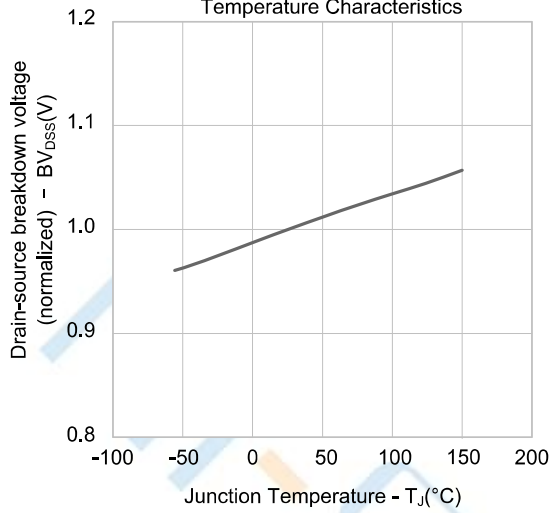

Figure 8. On-resistance vs. Temperature Characteristics

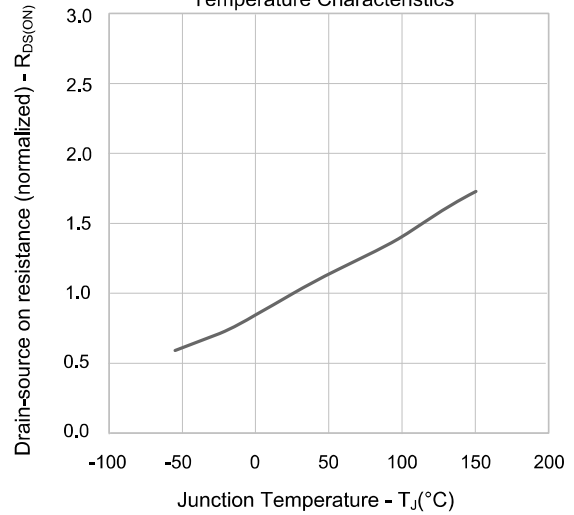
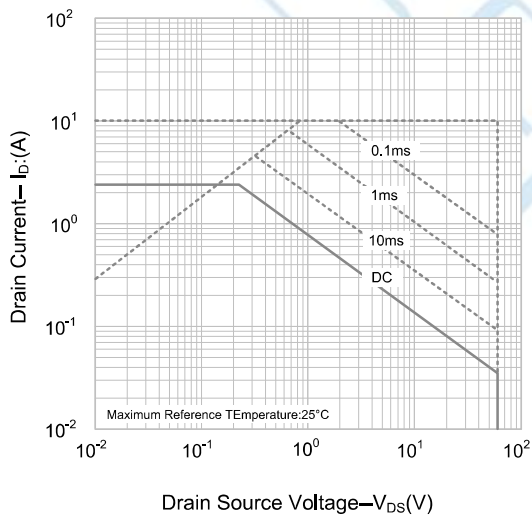
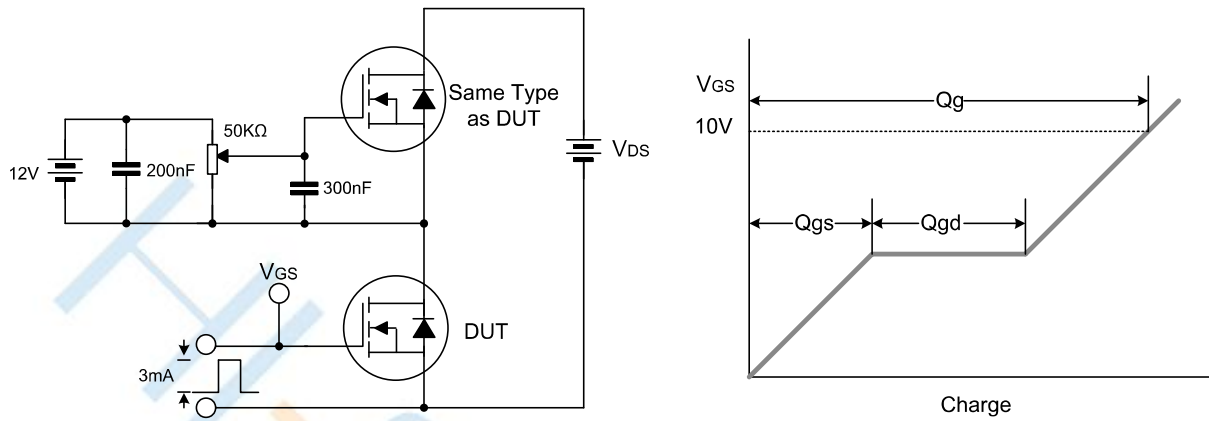

Figure 9. Max. Safe Operating Area



Test Circuit

Gate Charge Test Circuit & Waveform



Resistive Switching Test Circuit & Waveform

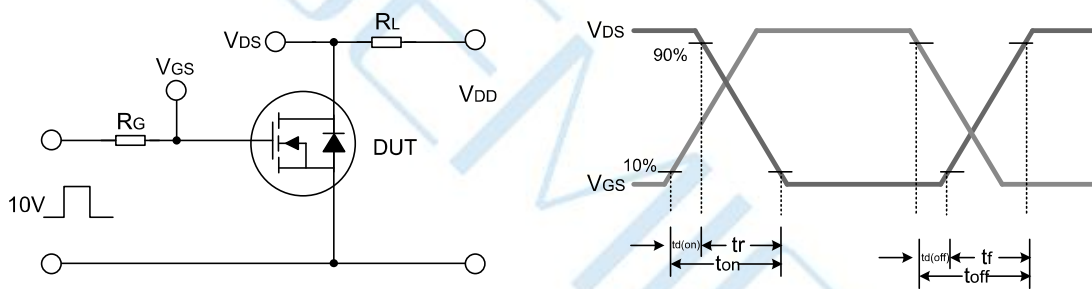

Unclamped Inductive Switching Test Circuit & Waveform

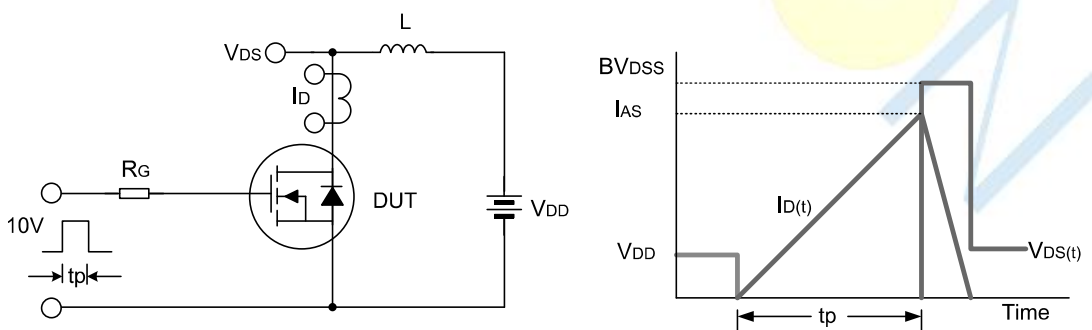

Package Dimensions of SOT-23-3L

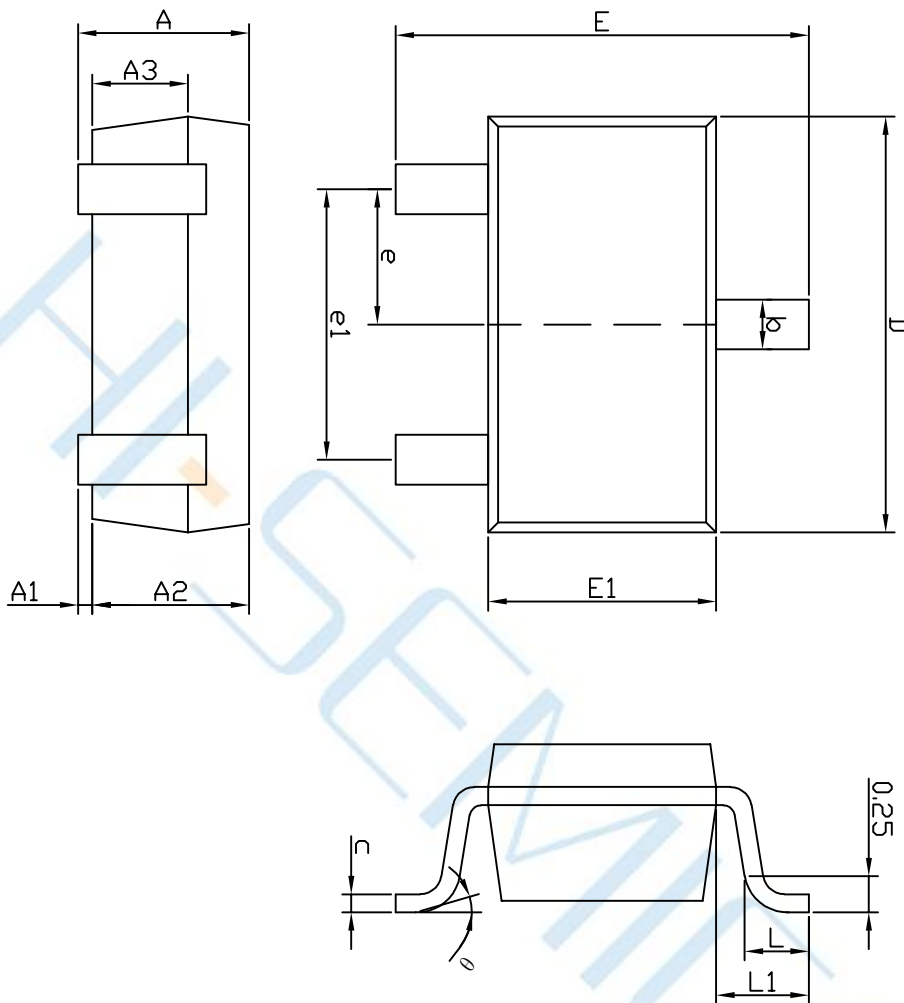

COMMON DIMENSIONS  
(UNITS OF MEASURE=MILLIMETER)

SYMBOL	MIN	NOM	MAX
A	-	-	1.25
A1	0.04	-	0.10
A2	1.00	1.10	1.20
A3	0.60	0.65	0.70
b	0.33	-	0.41
c	0.11	-	0.20
D	2.82	2.92	3.02
E	2.60	2.80	3.00
E1	1.50	1.60	1.70
e	0.95BSC		
e1	1.90BSC		
L	0.30	-	0.60
L1	0.60REF		
θ	0°	-	8°

Package Dimensions of SOT-23

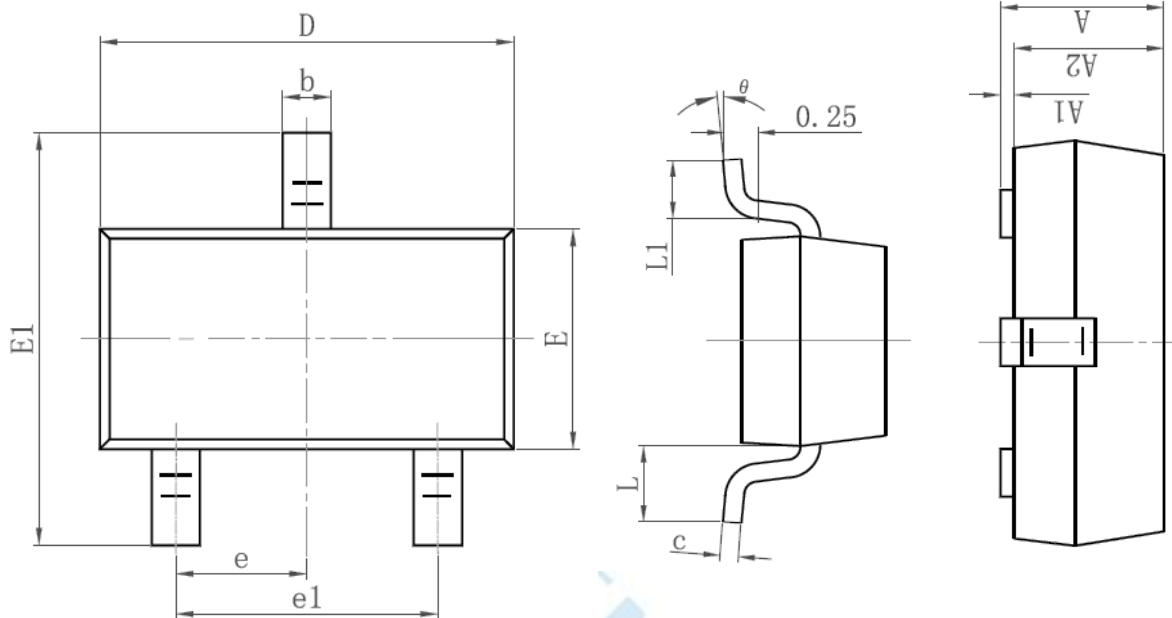

Symbol	Dimensions in Millimeters	
	MIN.	MAX.
A	0.900	1.150
A1	0.000	0.100
A2	0.900	1.050
b	0.300	0.500
c	0.080	0.150
D	2.800	3.000
E	1.200	1.400
E1	2.250	2.550
e	0.950TYP	
e1	1.800	2.000
L	0.550REF	
L1	0.300	0.500
$\theta$	0°	8°



**Disclaimer:**

- ▶ Hi-semicon reserves the right to make changes to the information herein for the improvement of the design and performance without further notice! Customers should obtain the latest relevant information before placing orders and should verify that such information is complete and current.
- ▶ All semiconductor products malfunction or fail with some probability under special conditions. When using Hi-semicon products in system design or complete machine manufacturing, it is the responsibility of the buyer to comply with the safety standards strictly and take essential measures to avoid situations in which a malfunction or failure of such Hi-semicon products could cause loss of body injury or damage to property.
- ▶ Hi-semicon will supply the best possible product for customers!